

Data Sheet



Article number: 204260M1050A1S

Description: E+G levelling foot

GN 42-60-M10-50-A1-S

Note: S Without nut, External hexagon at the bottom

Measures

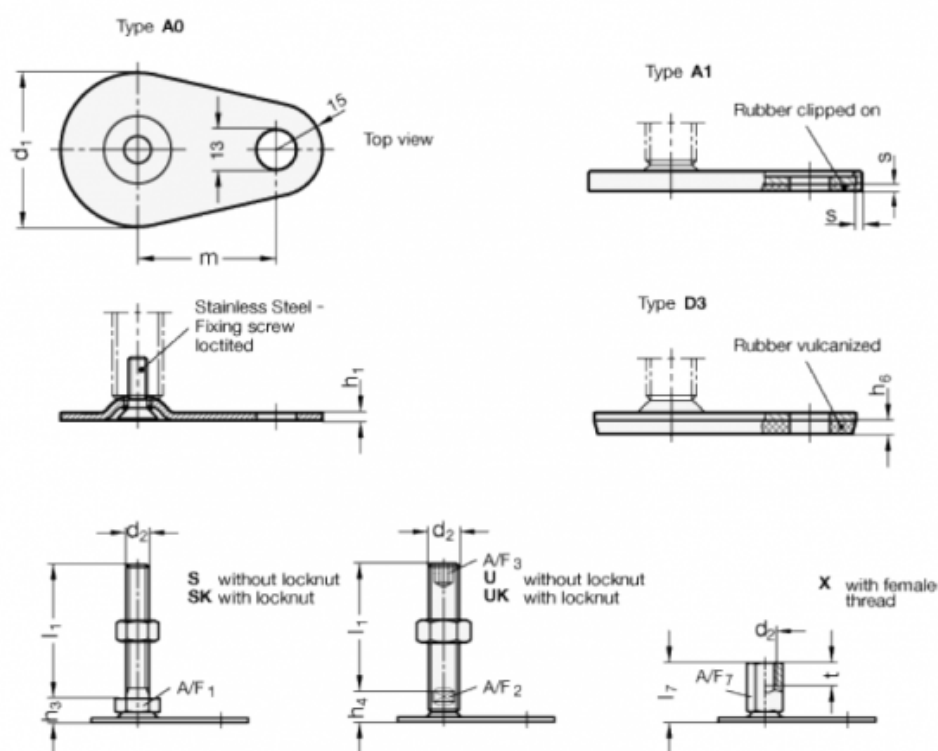

A/F1 = 17

s = 2

d1 = 60

d2 = M10

h1 = 2.5

h3 = 11

h6 =

l1 = 50

m = 50